



921106120

ROUGH COUNTRY

SUSPENSION SYSTEMS®

JEEP 2019-UP JL Unlimited Roof Rack

Thank you for choosing Rough Country for all your vehicle needs.

Please read instructions before beginning installation. Check the kit hardware against the kit contents shown below. Be sure you have all needed parts and know where they go.

If question exist, please call us @1-800-222-7023. We will be happy to answer any questions concerning this product. Check all fasteners for proper torque.

Periodically check all hardware for tightness.

KIT CONTENTS:

- 1-Right Side Panel with Logo
- 1- Left Side Panel with Logo
 - 1- Front Panel
 - 1-Rear Panel
- 4-Cross Bars
- 1- Cross Brace
- 2- Rear Roof mounts
- 2-Roof Rack Mounts

TOOLS NEEDED:

- 5mm allen wrench
- 10mm Wrench / Socket
- 13mm Wrench / Socket

HARDWARE INCLUDED:

- 8mm x 25mm Hex Bolt x16
- 8mm x 25mm Button Head x34
- 8mm x 24mm Flat Washer x28
- 8mm x 16mm Flat Washer x54
- 8mm Lock Washer x26
- 8mm Nylock Nut x26
- 8mm Hex Nut x6
- Foam Pads x2
- Cable Ties-12

RC LED Lights Sold Separately:

- 50" LED Light Kit
- 2" Flush Mount Light Kit



Torque Specs:

Size	Grade 5	Grade 8	Size	Class 8.8	Class 10.9
5/16"	15 ft/lbs	20ft/lbs	6MM	5ft/lbs	9ft/lbs
3/8"	30 ft/lbs	35ft/lbs	8MM	18ft/lbs	23ft/lbs
7/16"	45 ft/lbs	60ft/lbs	10MM	32ft/lbs	45ft/lbs
1/2"	65 ft/lbs	90ft/lbs	12MM	55ft/lbs	75ft/lbs
9/16"	95 ft/lbs	130ft/lbs	14MM	85ft/lbs	120ft/lbs
5/8"	135ft/lbs	175ft/lbs	16MM	130ft/lbs	165ft/lbs
3/4"	185ft/lbs	280ft/lbs	18MM	170ft/lbs	240ft/lbs



INSTALLATION INSTRUCTIONS

1. Assemble the roof clamp pieces using (2) of the supplied 8mm x 25mm Button Head Bolt and 8mm x 16mm Flat Washers and lock washers into the welded nut on the side of the bracket. For the stud on top of the mount use (1) of the supplied 8mm x 16mm Flat Washers, 8mm lock washers, lock washers and an 8mm hex nut. Install the foam pad on the bottom of the mount as it will sit on the roof of the vehicle. **See Photo 1.**
2. Install the roof clamp down inside the gutter, resting the foam pad on top of the roof. **See Photo 2.**

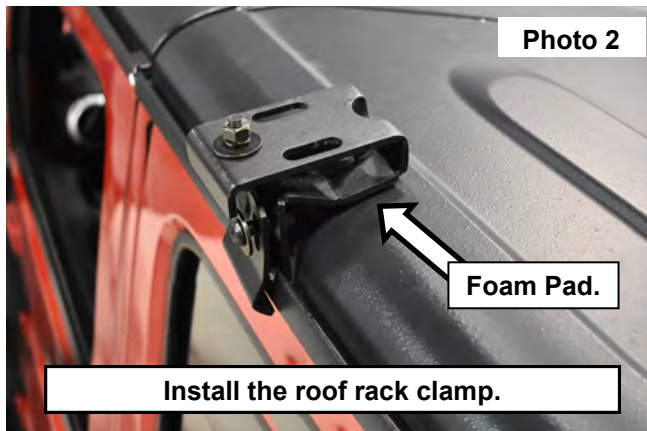
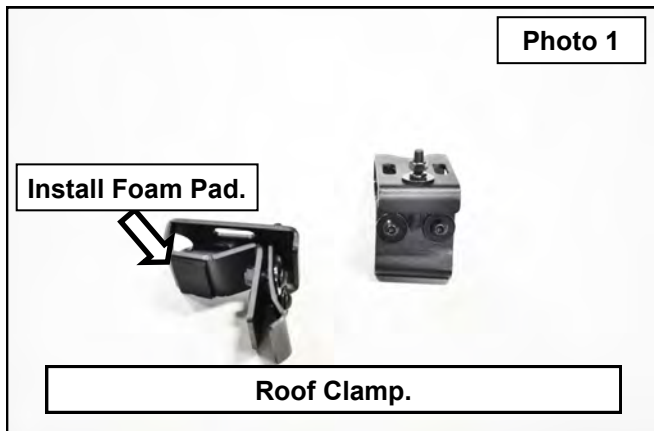

3. Measure 10 inches from the front side of the top, back over the rear doors toward the rear of the roof.
4. Set the roof clamp at a measurement of 9 inches from the front edge of the roof to the front edge of the roof clamp. **See Photo 3.** Tighten the nut on top, locking the clamp in place using a 13MM wrench. Tighten the 2 button head bolts on the side using a 5mm Allen wrench.
5. Open the rear window of the vehicle. Locating the 2 window struts. **See Photo 4.**

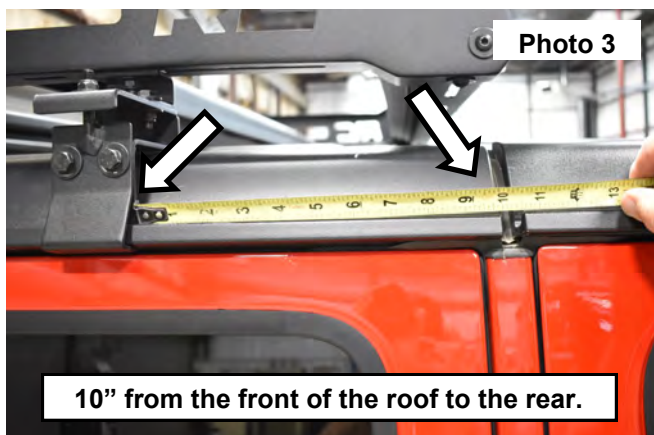

6. This step will require 2 people. Using a small pry tool pull the center tab out of the strut and release the strut from the mounting ball on each side of the window. **See Photo 5.**
7. Lower the window down into the closed position while keeping the struts inside of the vehicle.
8. Remove the hinge cover from the back glass. **See Photo 6.**



9. Perform this step one side at a time. Remove the 2 bolts on one side of the hinge of the back glass using a 10mm socket. Retain hardware for reuse. **See Photo 7.**
10. Locate the 2 rear roof mount brackets shown in **Photo 8.**



11. Pull the back glass out just enough to install the rear roof mounting bracket. Install the 2 retained bolts adjusting the bracket up against the top of the hinge pocket allowing enough room for the cover to work correctly. **See Photo 9.**
12. Install the cover onto the hinge and the back glass. **See Photo 10.**



13. Install the window struts onto the ball mount on both sides of the back glass. **See Photo 11.**
14. Locate the 2 roof rack mounting brackets shown in **Photo 12.**

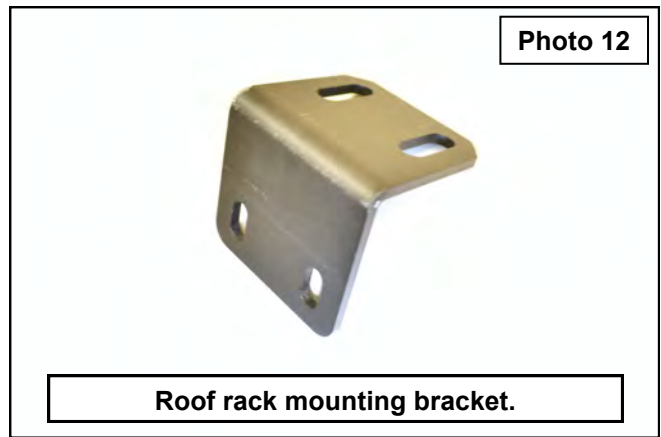

15. Install the roof rack mounting bracket onto the installed roof mount on the back window using (2) of the supplied 8mm x 25mm button head bolts and (4) 8mm x 16mm washer and (2) nylock nuts on each mount. **See Photo 13.**
16. Install the cross brace on each side of the roof clamp. **See Photo 14.**

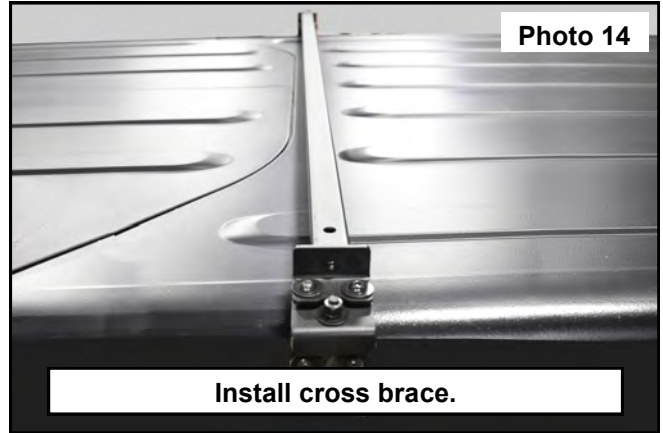
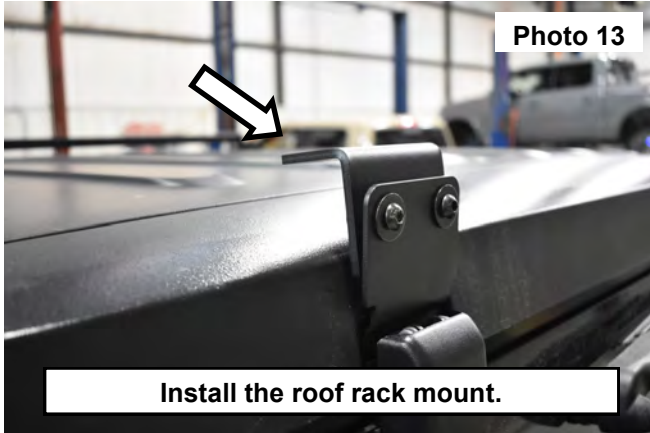

17. Secure the cross brace on each side to the roof clamp, using (2) of the supplied 8mm x 25mm button head bolts, (2) lock washers (4) 8mm x 16mm washers and (2) hex nuts. Tighten using a 5mm allen wrench and a 13mm wrench. **See Photo 15.**
18. Assemble the rear panel onto the right side panel using the supplied 8mm x 25mm button head allen bolts and the 8mm x 16mm washers and nylock nuts. **NOTE :** The RC logo will be located at the forward side of the side panel on both sides of the roof rack. **See Photo 16.** Do not tighten at this time.

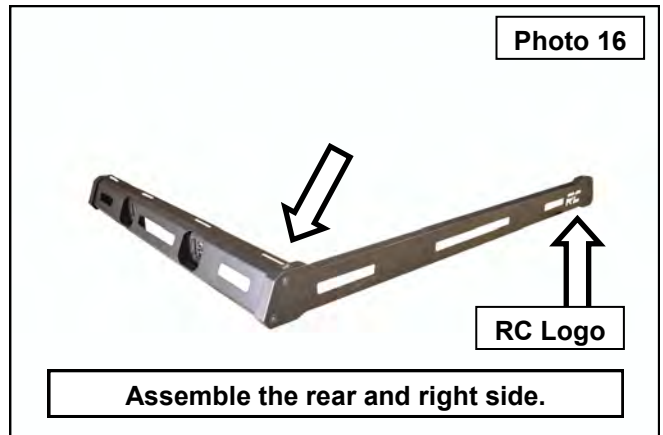
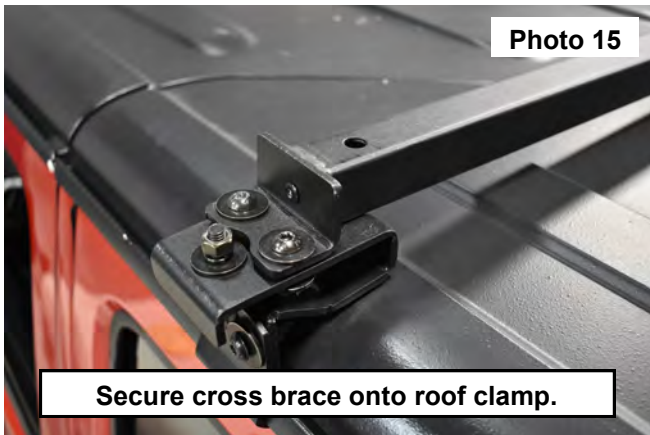

19. Install the front of the roof rack into the right side panel. Install the left side panel onto the front and the rear of the roof rack and secure using the supplied 8mm x 25mm button head allen bolts and the 8mm x 16mm washers and nylock nuts. **See Photo 17.** Do not tighten at this time. **NOTE :** Do not install the bottom 2 bolts into the front panel, they will be installed in a later step.
20. Place the 4 cross bars into the roof rack. **See Photo 12.** **See Photo 18.**

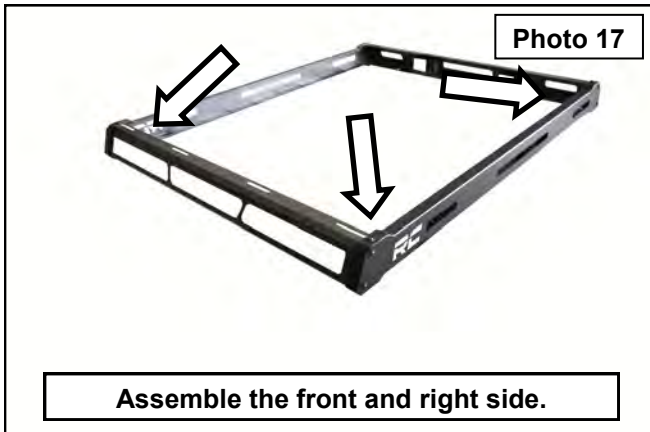

21. Install the roof rack on top of the rear mounts and the cross brace in the front. **See Photo 19.**
22. Install the 8mm x 25mm hex head bolts, 8mm x 25mm washers and 8mm nylock nuts into the roof rack and the cross brace on each side of the roof rack. **See Photo 20.** Tighten using a 13mm wrench and socket.

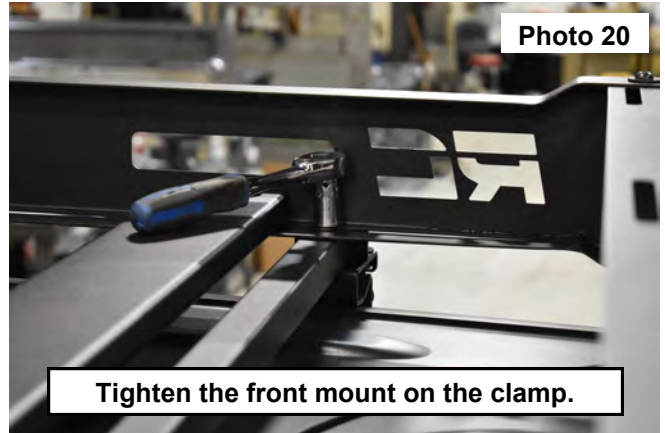

23. Install the 8mm x 25mm button head bolts, 8mm x 25mm washers and 8mm nylock nuts into the roof rack and the rear mounts on each side of the roof rack. **See Photo 21.** Tighten using a 5mm allen wrench and a 13mm wrench.
24. Install the 8mm x 25mm Hex head bolts (16) 8mm lock washers and (16) 8mm x 25mm washers in the cross bars. Tighten the bolts in the (4) cross bars on the roof rack, use a 13mm wrench. **See Photo 22 & 23.**

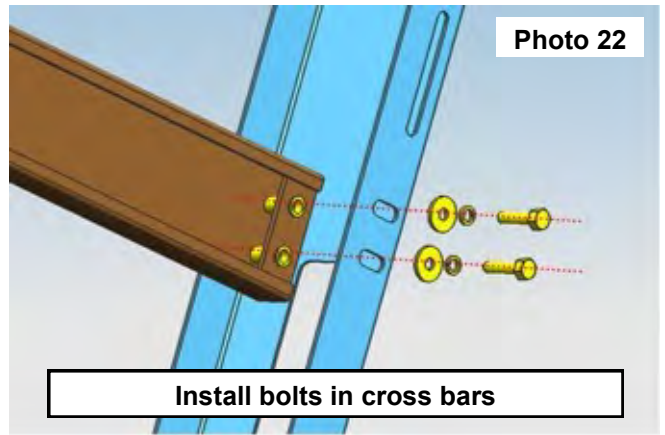
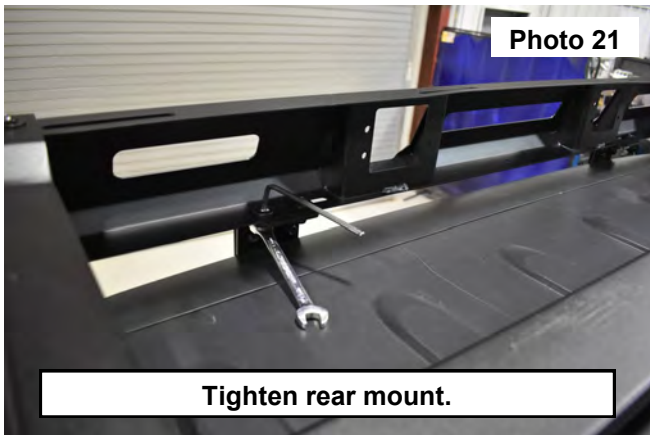

25. Install the (2) flush mount LED lights, using their corresponding instruction sheets.
26. Install the (2) 50" LED light brackets on the front of the roof rack, one on each side, using (2) 8mm x 25mm button head bolts, (2) 8mm x 16mm washers on bottom, securing the bracket on the inside, using (2) 8mm x 16mm flat washers and (2) 8mm nylock nuts. **See Photo 24.** Tighten using a 5mm allen and a 13mm wrench.

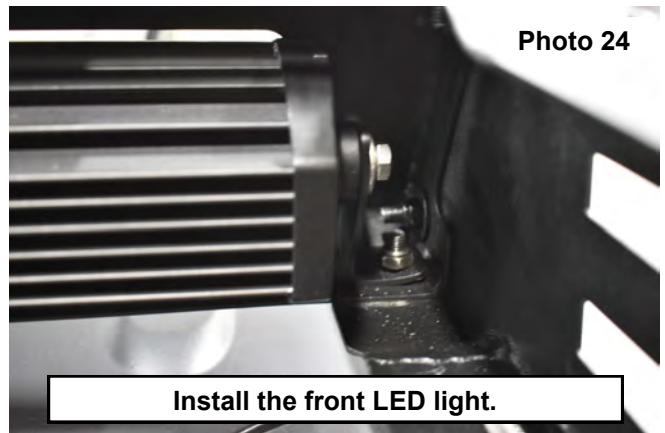

27. Install the LED light bar into the brackets installed on the front of the roof rack, secure with supplied hardware in the light kit . **See Photo 25.**
28. Secure the wiring along the slots to the back of the roof rack using supplied cable ties. **See Photo 20.**
29. Run the wiring inside of the window track to the bottom of the roof and inside of the vehicle under the seal as shown in **Photos 26 and 27.**

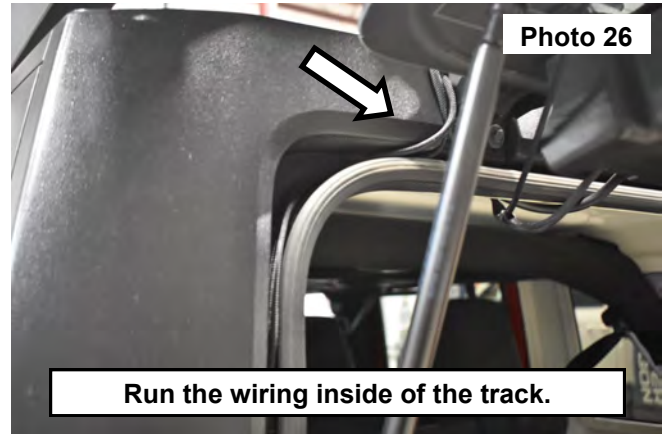
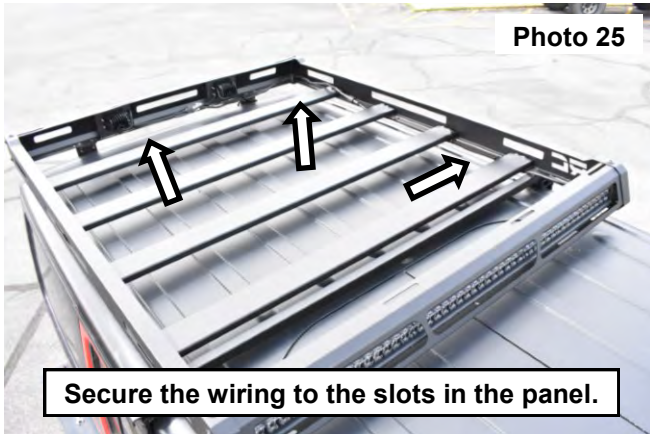

30. Make sure the wiring is by the opening in the hinge when the window is closed. **See Photo 28.**

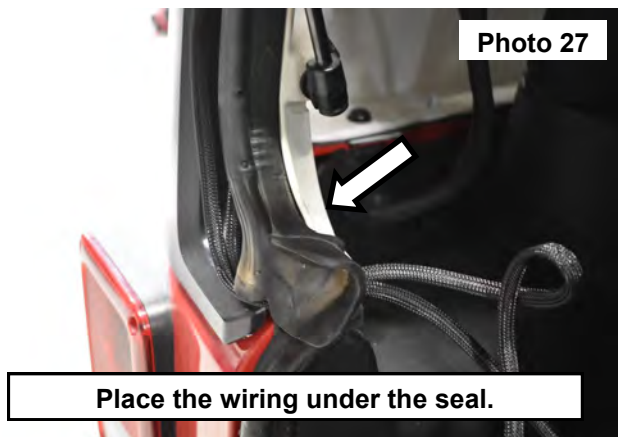

31. Adjust the light to the desired angle. Tighten using a 13mm wrench. **See Photo 29.**



By purchasing any item sold by Rough Country, LLC, the buyer expressly warrants that he/she is in compliance with all applicable , State, and Local laws and regulations regarding the purchase, ownership, and use of the item. It shall be the buyers responsibility to comply with all Federal, State and Local laws governing the sales of any items listed, illustrated or sold. The buyer expressly agrees to indemnify and hold harmless Rough Country, LLC for all claims resulting directly or indirectly from the purchase, ownership, or use of the items.

